

3

Contactors

SH-1P, SH2P, SH-3P Series

Fuse holder for stripe fuses to
DIN 43560

Catalogue B101.en

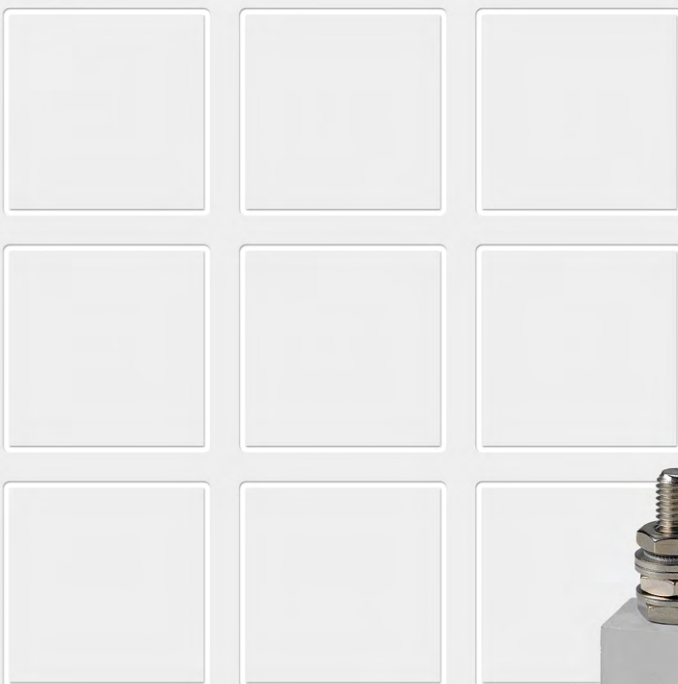

More information
schaltbau.com

SH-xP 1-, 2- and 3-pole fuse holder for stripe fuses to DIN 43560

Fuse holders for stripe fuses to DIN 43560 are designed for use in battery powered vehicles covering voltages up to 80 V. Fuse ratings may range from 50 A to 425 A.

We offer fuse holders admitting 1, 2 or 3 stripe fuses. Tie bars for 2 or 3 poles are available.

The fuse holders are designed for a wide range of ambient temperatures up to 70° C max.

Hexagonal screws, bolts and washers are made from nickel-plated brass.

Copper sheet tie bars are available for our 2 and 3 pole fuse holders.

Description	Weight	Ordering code
Fuse holder 1 pole type	approx. 150 g	SH-1P
Fuse holder 2 pole type	approx. 300 g	SH-2P
Fuse holder 3 pole type	approx. 450 g	SH-3P
Tie bar 2 pole type	approx. 30 g	VS-SH-2P-32.5-4
	approx. 25 g	VS-C165-32.5
Tie bar 3 pole type	approx. 40 g	VS-SH-3P-65-3

Dimension diagram

• **SH-1P** 1-pole fuse holder

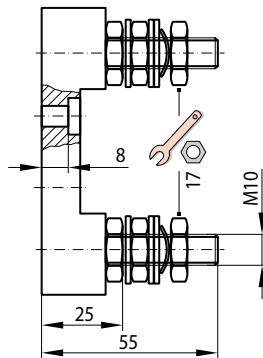
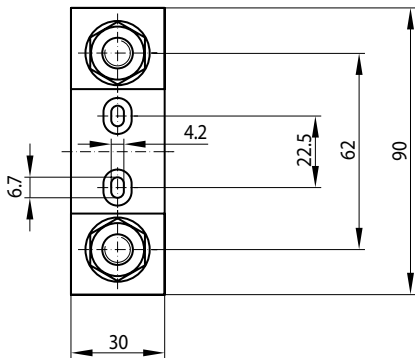

• **VS-SH-3P-65-3** 3-pole tie bar

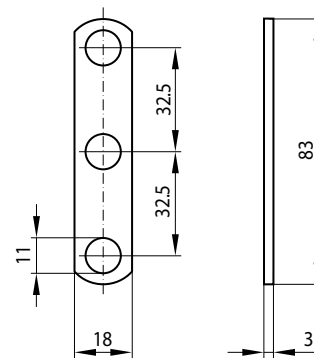

• **SH-2P** 2-pole fuse holder

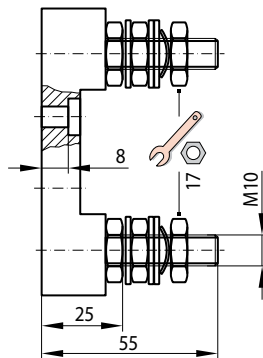
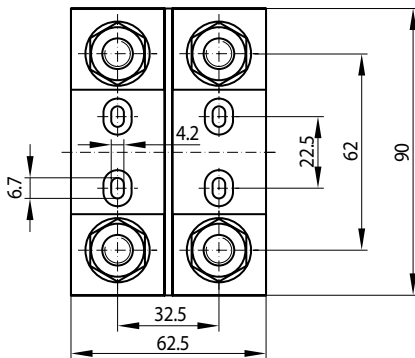

• **VS-SH-2P-32.5-4** 2-pole tie bar

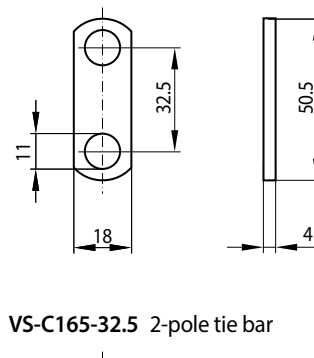

• **SH-3P** 3-pole fuse holder

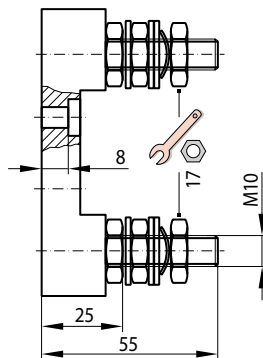
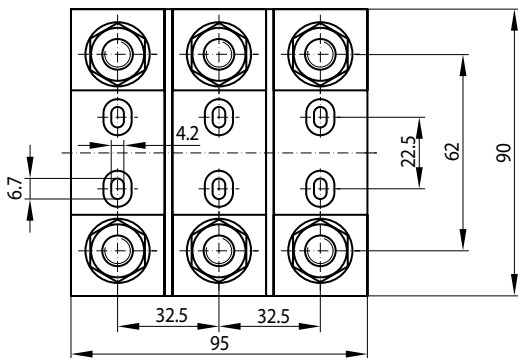

• **VS-C165-32.5** 2-pole tie bar

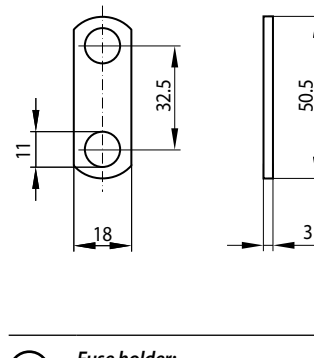

Fuse holder:

The lower hexagonal nut was tightened by 4 Nm. All other nuts to be tightened by 16 Nm max.

Dimensions in mm



Find your worldwide contact person. We are here for you, personally!

Schaltbau GmbH
contact@schaltbau.de
www.schaltbau.com

We reserve the right to make technical alterations without prior notice. For updated product information visit www.schaltbau.com

Flyer, PDF only B1757/2307/0